

金属材料一站式采购
让采购变的容易

One-Stop solution for Metal Raw Material
Making Purchase Easy



金明简德
JIN MING JIAN DE



☎ TEL: 86 0510 88992105

✉ EMAIL: info@wxjmdss.com

🌐 WEB: <http://www.steeltd.com>

📍 OFFICE ADDRESS: 2102-2105, Yuexing Building, Guangyi Road, Liangxi District, Wuxi Jiangsu, CN

📍 FACTORY ADDRESS: Nongshi Road, #07, Dongbei Tang District, Xi Shan, Wuxi Jiangsu, CN, Zip: 214000

无锡金明简德科技有限公司

WUXI JIN MING JIAN DE INDUSTRY&TRADE CO., LTD

目录

CONTENTS

品牌篇 Brand

- 01 公司创始人 Founder of the company
- 02 发展历史 Development history
- 03 企业简介 Enterprise Profile

产品篇 Products

- 01 不锈钢 Stainless Steel
- 02 铝 Aluminium

仓储、加工、包装 Stock、process、Packing

- 01 仓储中心 Stock
- 02 加工中心 Process Center
- 03 包装 & 装柜 Packing & Loading

质检篇 Quality Inspection

- 01 检测报告 Test Report
- 02 第三方检验 Third Party Inspection



库存充足
Adequate Stock



质量保证
Quality Assurance



售后保障
After-sales Guarantee

FOUNDER OF THE COMPANY

公司创始人



XUEXU LIU

刘学绪

Wuxi Cross-border Internet Merchants Association

Shandong Chamber of Commerce in Wuxi City

Wuxi Jin Ming Jian De Industry & Trade Co.,Ltd

2015 Alibaba East China Region Sharing Masters Tournament

Wuxi Vocational and Technical College of Commerce

无锡跨境网商商会

无锡市山东商会

无锡金明简德科技有限公司

2015阿里巴巴华东大区分享达人赛

无锡商业职业技术学院

Honorary President

Vice president

Chairman of the Board

Champion

Cross-border e-commerce mentor

名誉会长

副会长

董事长

总冠军

跨境电商导师

In 2013, engaged in cross-border e-commerce industry

In 2014, Wuxi Jin Ming Jian De Industry & Trade Co.,Ltd

In 2015, established.Wuxi Cross-border E-commerce Association

In 2015, signed a contract as a gold lecturer of Alibaba cross-border business division of sharing network business

In 2016, Alibaba organized the Shanghai • Su • Hui Online Merchants Sharing Talent Competition, and won the overall champion of Alibaba East China Region Sharing Online Merchants Talent Competition from more than 2,000 online business, entrepreneurs. In that year, he toured more than 100 speeches

all over the country, influenced and guided more than 20,000 cross-border e-commerce enterprises, and received more than 5,000 people from all over the country to visit and study in our company. In the same year, in cooperation with the government of Liangxi District, Liangxi District cross-border e-commerce incubation base was established.

In 2017, it won the honorary title of Jiangsu Cross-border E-commerce Demonstration Base. In 2017, he initiated and established Wuxi Shandong Chamber of Commerce for 300,000 people in Wuxi, and served as vice president and director of cross-border e-commerce committee of Shandong Chamber of Commerce. In 2018 Established cross-border e-commerce training base in Wuxi Taihu University to serve cross-border e-commerce enterprises in Wuxi and surrounding markets.

In 2019, successfully assisted Wuxi Taihu University to apply for and set up Wuxi Cross-border E-commerce Business School.

In 2020, under the influence of the international environment, engaged in foreign trade of epidemic prevention materials.

In 2021, returned to the steel industry, new aluminum, carbon steel, galvanized and other steel categories

I have been committed to the cross-border e-commerce industry, and have influenced the local cross-border e-commerce industry in Wuxi with my actual actions. I have also been growing on the road of sharing. "Growing together and sharing resources" is my firm belief on the road of sharing.

2013年从事跨境电商行业

2014年成立无锡金明简德科技有限公司

2015年成立跨境电商社团组织，即无锡跨境网商商会。

2015年签约阿里巴巴跨境事业部分享型网商企业金牌讲师

2016年阿里巴巴组织沪·苏·徽网商分享达人赛，从2000余名网商企业家当中，获得阿里巴巴华东大区分享型网商达人赛总冠军。于当年全国各地巡回演讲100余场，影响并指导了跨境电商企业2万余家，接待了全国各地来我公司参观学习人数达5000余人。并于同年与梁溪区政府合作，成立了梁溪区跨境电商孵化基地。

2017年获得江苏省跨境电商示范基地荣誉称号。

2017年为山东驻无锡30万人发起并成立了无锡市山东商会，并担任副会长、山东商会跨境电商委员会主任。

2018年在无锡太湖学院成立了跨境电商实训基地，服务无锡及周边市场的跨境电商企业。

2019年成功协助无锡太湖学院申请并成立了中国无锡跨境电商学院。

2020年受国际大环境影响，从事防疫物资的对外贸易

2021年重回钢材行业，新增铝材，碳钢，镀锌等钢材品类

本人一直致力于跨境电商行业，以自己的实际行动影响着无锡本地的跨境电商行业，也一直在分享的路上成长，“抱团成长，资源共享”是我一直在分享路上的坚定信念。

DEVELOPMENT HISTORY

发展历程

The development history of JMJD
金明简德发展历程

不忘初心，砥砺前行
Never forget why you started, and forge ahead with determination

2009 年

创始人刘学绪先生创立了最初的不锈钢销售公司。主要做国内市场。

Founder Mr. Liu Xuexu established the initial stainless steel sales company, mainly serving the domestic market.

2010 年

公司团队组建

Company team established

2011 年

我们的阿里巴巴平台上线了，我们开始了不锈钢出口贸易。

Our Alibaba platform is now online, and we have begun exporting stainless steel.

2012 年

阿里巴巴平台增加到6个。

The number of Alibaba platforms we operate on has increased to six.

2013 年

公司制度进一步完善，新增运营部门

The company system was further improved, and new operating departments were added.

2014 年

我们更名为金明简德，人数增长到49人，开始了铝出口

We renamed ourselves as JMJD, employees has grown to 49, starting to export aluminum.

2015 年

2015年我们稳步发展，搬进了新办公室

we developed steadily and moved into a new office.

2016 年

刘学绪先生发起成立无锡商会并任首任会长，我司成为会长单位

Mr. Liu Xuexu initiated the establishment of the Wuxi -Commerce Chamber of Commerce and served as the first president. We became the chairman company.

2017 年

刘学绪先生担任山东商会副会长，我们成为无锡山东商会副会长单位

Mr. Liu Xuexu served as the vice president of Shandong Chamber of Commerce, We became the vice chairman company.

2018 年

我们的进出口额突破往年，业绩翻倍

Our import and export volume exceeded previous years, and our performance doubled.

2019 年

我们拥有了自己的储存仓库和加工中心

We have our own storage warehouse and processing center.

2020 年

我们又增加几台新设备，生产效率进一步提高

We have added several new equipment to further improve production efficiency.

2021 年

质检，售后部门的制度进一步完善，积累了大量的老客户，公司处于稳步发展

Quality control and after-sales department's systems have been further improved, accumulating a large number of loyal customers, and the company is in a steady development.

品牌篇
BRAND

01
PART ONE

QUALITY CERTI-
FICATION
产品大纲

<https://www.steelttd.com> 

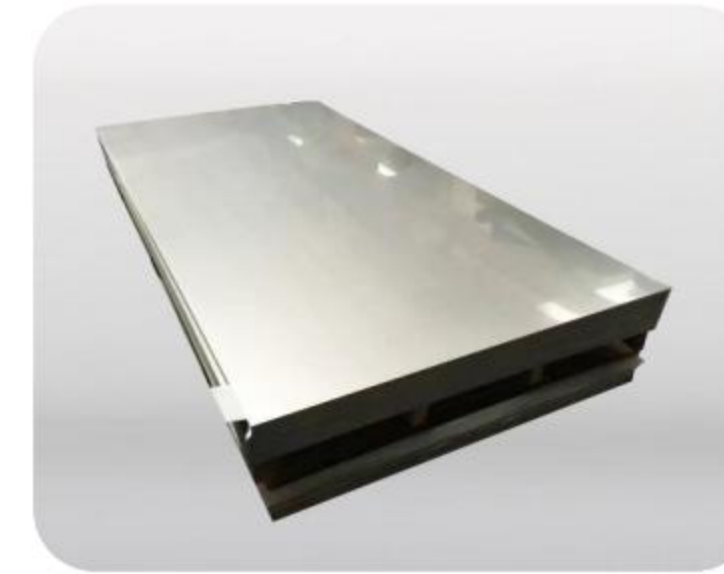

stainless steel sheet

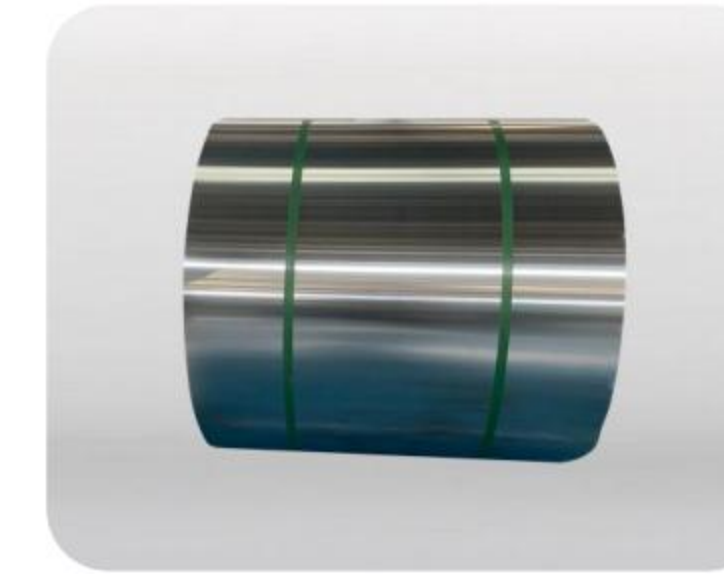

stainless steel coil



stainless steel pipe



stainless steel round bar

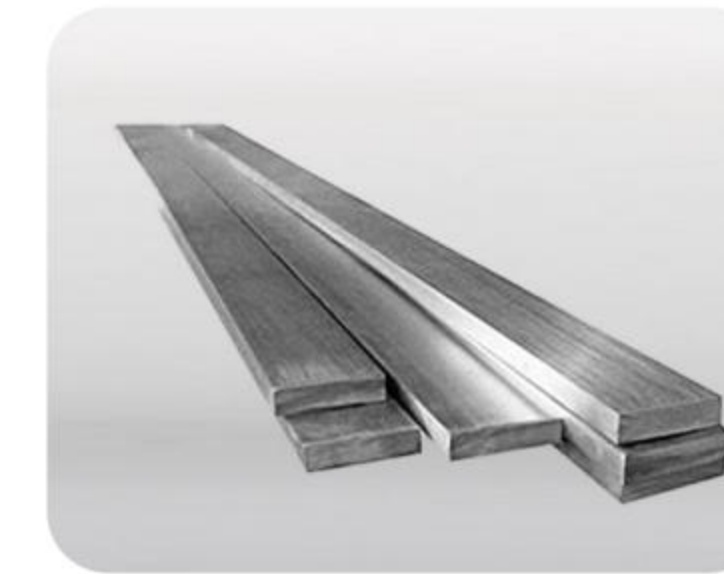

stainless steel flat bar

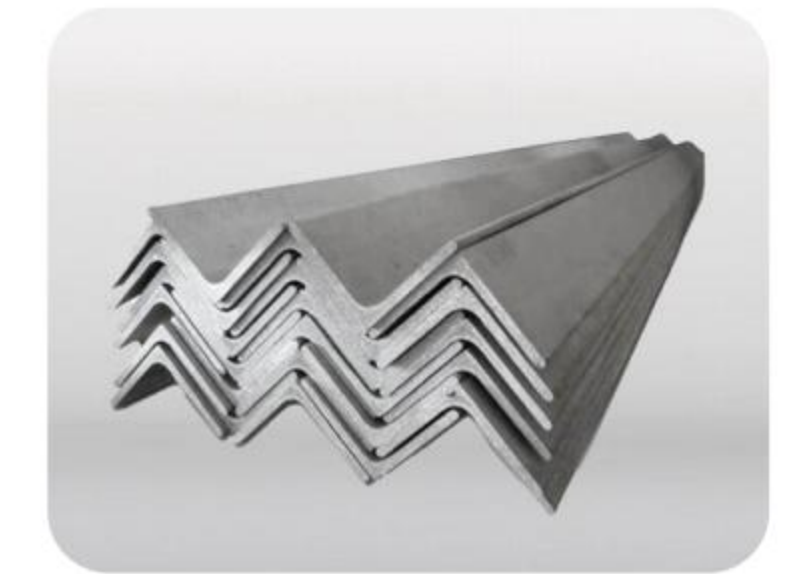

stainless steel angle bar

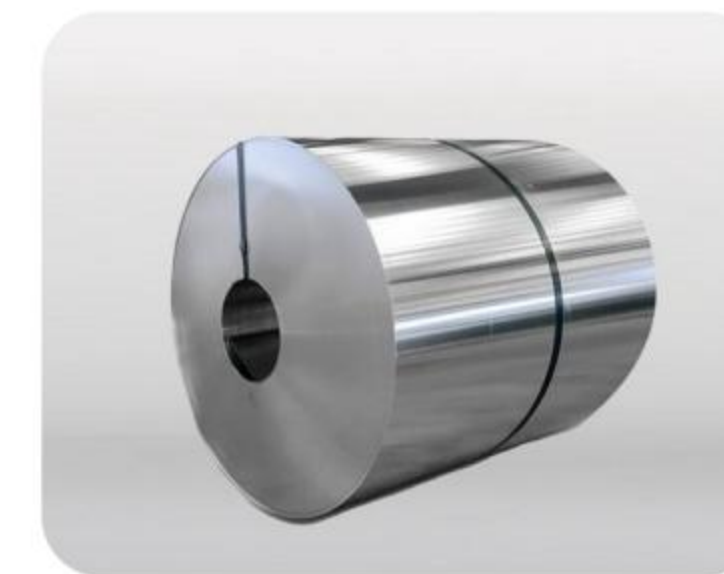

aluminum coil

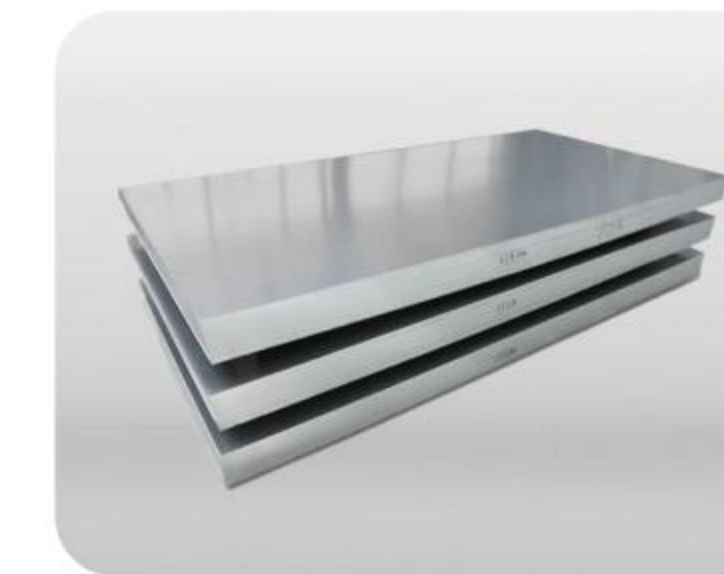

aluminum sheet

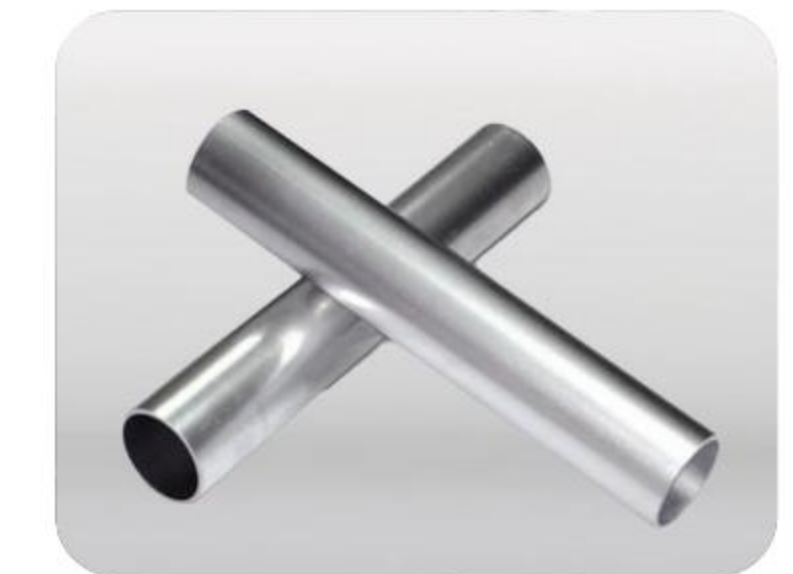

aluminum tube



aluminum billets

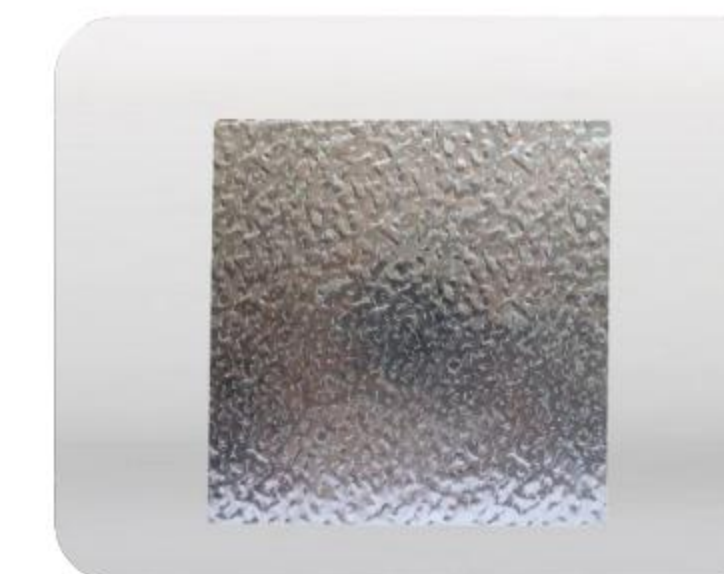

aluminum embossed plate



aluminum ingot

品牌篇
BRAND

ENTERPRISE PROFILE

企业简介

Welcome to JMJD, a trusted name in the world of stainless steel and , aluminum exporting. Established in 2009, we have quickly become a reliable and respected supplier of high-quality materials to clients across the globe.

Our commitment to quality is at the heart of everything we do. We work closely with our suppliers to ensure that every product we offer meets the strictest standards for durability, reliability, and performance. From stainless steel aluminum sheets , we have the expertise and resources to provide you with the materials you need to get the job done right.

At JMJD, we pride ourselves on our exceptional customer service. Our team of experts is dedicated to providing you with personalized solutions that are tailored to your specific needs. From product sourcing and logistics to delivery and after-sales support, we are committed to ensuring that you have the best possible experience when working with us.

We understand that our success depends on your success, which is why we go above and beyond to ensure that every order is delivered on time, on budget, and to your exact specifications. Whether you are a large corporation or a small business, we are here to help you succeed by providing you with the materials you need to build your business and achieve your goals.

Thank you for considering JMJD for your stainless steel, aluminum, and carbon steel needs. Contact us today to learn more about how we can help you succeed.

欢迎来到金明简德,我们是在不锈钢、铝出口领域值得信赖的品牌。我们成立于2009年,现已迅速成为全球客户可靠且受人尊敬的优质材料供应商。

我们对质量的承诺是我们所做一切的核心。我们与供应商密切合作,以确保我们提供的每件产品都符合最严格的耐用性、可靠性和性能标准。从不锈钢到铝板等,我们拥有专业知识和资源,可为您提供正确完成工作所需的材料。

在金明简德,我们以卓越的客户服务而自豪。我们的专家团队致力于为您提供根据您的特定需求量身定制的个性化解决方案。从产品采购和物流到交付和售后支持,我们致力于确保您在与我们合作时获得最佳体验。

我们明白我们的成功取决于您的成功,这就是为什么我们竭尽全力确保每份订单按时、按预算交付并符合您的确切规格。无论您是大公司还是小企业,我们都在这里通过为您提供建立业务和实现目标所需的材料来帮助您取得成功。

感谢您考虑使用金明简德来满足您对不锈钢、铝和碳钢的需求。立即联系我们,详细了解我们如何帮助您取得成功。

办公环境
OFFICE ENVIRONMENT



产品篇

PRODUCT

02

PART TWO

STAINLESS STEEL 不锈钢

<https://www.steelttd.com> 

Stainless Steel Cold Rolled Sheet 不锈钢冷轧板



Grade : 201 430 304 304L 316 316L 321 309s 310s 2205 904L etc.
Technique : Cold Rolled
Thickness : 0.3-6.0mm
Width : 1000/1219/1250/1500mm or as your request
Length : 2000/2438/3000/6000mm or as your request
Edge : Slit,Mill
Surface : 2B/BA/NO.4/8K/HL

等级 : 201 430 304 304L 316 316L 321 309s 310s 2205 904L etc.
工艺:冷轧
厚度 : 0.3-6.0mm
宽度 : 1000/1219/1250/1500mm 或按客户要求定制
长度 : 2000/2438/3000/6000mm 或按客户要求定制
边缘 : 切边, 毛边
表面: 2B/BA/NO.4/8K/HL

Stainless Steel Cold Rolled Coil 不锈钢冷轧卷

Grade : 201 430 304 304L 316 316L 321 309s 310s 2205 904L etc.
Technique : Cold Rolled
Thickness : 0.3-6.0mm
Width : 1000/1219/1250/1500mm or as your request
Length : As your request
Edge : Slit,Mill
Surface : 2B/BA/NO.4/8K/HL

等级 : 201 430 304 304L 316 316L 321 309s 310s 2205 904L etc.
工艺:冷轧
厚度 : 0.3-6.0mm
宽度 : 1000/1219/1250/1500mm 或按客户要求定制
长度 : 或按客户要求定制
边缘 : 切边, 毛边
表面: 2B/BA/NO.4/8K/HL



不锈钢
STAINLESS STEEL

STAINLESS STEEL 不锈钢

Stainless Steel Hot Rolled Sheet 不锈钢热轧板

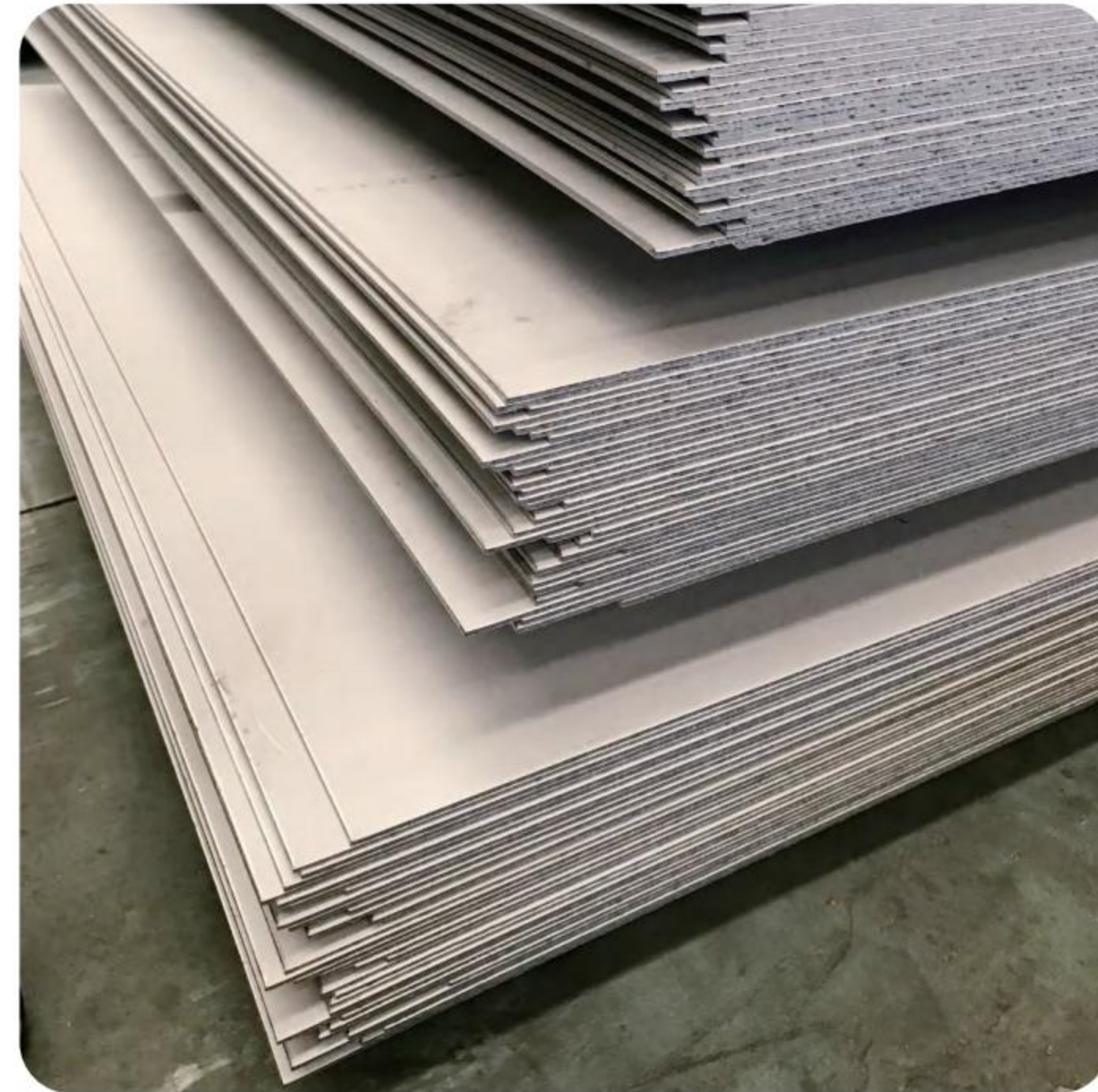

Grade : 201 430 304 304L 316 316L 321 309s 310s 2205 904L etc.
Technique : Hot Rolled
Thickness : 3.0-100mm
Width : 1500/1800/2000mm or as your request
Length : 2438/3000/6000mm or as your request
Edge : Slit,Mill
Surface : No.1

等级：201 304L 201 430 321 309s 310s 2205 904L等。
工艺：热轧
厚度：3.0-100mm
宽度：1500/1800/2000mm 或按客户要求定制
长度：2438/3000/6000mm 或按客户要求定制
边缘：切边，毛边
表面：No.1

Stainless Steel Hot Rolled Coil 不锈钢热轧卷

Grade : 201 430 304 304L 316 316L 321 309s 310s 2205 904L etc.
Technique : Hot Rolled
Thickness : 3.0-14mm
Width : 1500/1800/2000mm or as your request
Length : As your request
Edge : Slit,Mill
Surface : No.1

等级：201 304L 201 430 321 309s 310s 2205 904L等。
工艺：热轧
厚度：3.0-14mm
宽度：1500/1800/2000mm 或按客户要求定制
长度：或按客户要求定制
边缘：切边，毛边
表面：No.1



Stainless Steel Welded Pipe 不锈钢焊管

Grade: 201, 202,2205, 2507,304, 304L, 321, 316, 316L, 309S, 310S, 410, 420, 430,444, 904L, etc.
Thickness: 0.5-10mm
Outer diameter: 10-219mm
Length: 6m or as customer's requirement
Finish: Polished, Pickled, hairline, mirror
Shape: Round, square, rectangular, oval
Technology: Welded
Packaging: Standard exporting packing
Standard: JIS, AISI, ASTM, GB, DIN, EN, etc.

等级：201, 202,2205, 2507,304, 304L, 321, 316, 316L, 309S, 310S, 410, 420, 430,444, 904L,等。
厚度：0.5-10mm
外径：10-219mm
长度：6m或根据客户要求
表面处理：抛光，酸洗，拉丝，镜面
形状：圆形、方形、长方形、椭圆形
技术：焊接
包装：标准出口包装
执行标准：JIS, AISI, ASTM, GB, DIN, EN

Stainless Steel Seamless Pipe 不锈钢无缝管

Grade: 201, 202,2205, 2507,304, 304L, 321, 316, 316L, 309S, 310S, 410, 420, 430,444, 904L, etc.
Thickness: 1.0-12mm
Outer diameter: 6-630mm
Length: 6m or as customer's requirement
Finish: Polished, Pickled, hairline, mirror
Shape: Round, square, rectangular, oval
Technology: Seamless
Packaging: Standard exporting packing
Standard: JIS, AISI, ASTM, GB, DIN, EN, etc.

等级：201, 202,2205, 2507,304, 304L, 321, 316, 316L, 309S, 310S, 410, 420, 430,444, 904L等。
厚度：1.0-12mm
外径：6-630mm
长度：6m或根据客户要求
表面处理：抛光，酸洗，拉丝，镜面
形状：圆形、方形、长方形、椭圆形
技术：无缝
包装：标准出口包装
执行标准：JIS, AISI, ASTM, GB, DIN, EN



STAINLESS STEEL

不锈钢



Stainless Steel Flat Bar 不锈钢扁钢

Width: 10-400mm or as customer's requirements
 Thickness: 0.6-25mm, or as customer's requirements
 Length: 1000-6000mm or as requirements
 Finish: Hairline, Polished, Annealing
 Grade: 201, 202, 301, 302, 303, 304, 304L, 304N1, 309S, 310S, 316, 316L, 316Ti, 316N, 317, 317L, 321, 409L, 410, 420, 430, 904, 904L, etc
 Standards: AISI ASTM JIS SUS DIN GB
 Packing: Industry standard packaging or according to client's requirement
 Delivery time: 10-20 Days

宽度:10-400mm或根据客户要求
 厚度:0.6-25mm, 也可根据客户要求定做
 长度:1000-6000mm或根据要求
 表面处理:拉丝, 抛光, 退火
 等级:201、202、301、302、303、304、304L、304n、309s、310S、316、316L、316Ti、316N、317、317L、321、409L、410、420、430、904、904L等
 标准:AISI ASTM JIS SUS DIN GB
 包装:按行业标准包装或按客户要求包装
 交货时间:10-20天

Stainless Steel Angle Bar 不锈钢角钢

Specification: 20*20-200*200mm
 Thickness: 3mm-12mm;(Size can be customized.)
 Finish: Pickling, Polish, Annealing
 Grade: 201, 202, 301, 302, 303, 304, 304L, 304N1, 309S, 310S, 316, 316L, 316Ti, 316N, 317, 317L, 321, 409L, 410, 420, 430, 904, 904L, etc
 Standards: AISI ASTM JIS SUS DIN GB
 Packing: Industry standard packaging or according to client's requirement
 Delivery time: 7-20 days

规格:20 * 20 - 200 * 200毫米
 厚度:3mm-12mm;(尺寸可定制)
 表面处理:酸洗, 抛光, 退火
 等级:201、202、301、302、303、304、304L、304n、309s、310S、316、316L、316Ti、316N、317、317L、321、409L、410、420、430、904、904L等
 标准:AISI ASTM JIS SUS DIN GB
 包装:按行业标准包装或按客户要求包装
 交货时间:7-20天

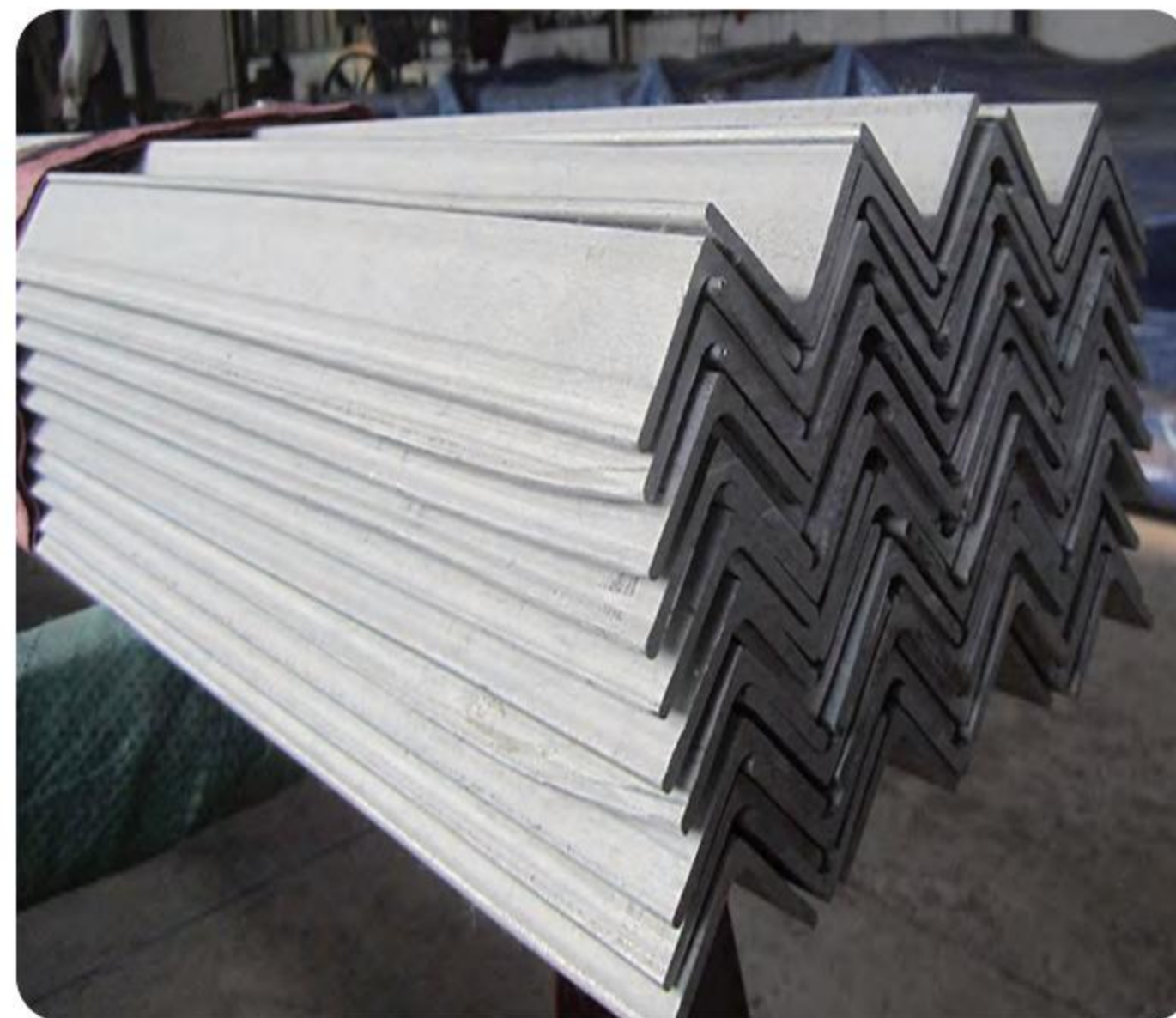

Stainless Steel Round Bar 不锈钢圆棒

Grade:201,202,304,304L,316,316L,430,310S,etc
 Diameter: 3-800mm or forged as your requirement
 Length: 6m or as customer's requirement
 Shape: Round
 Finish: Polished,Pickled
 Standard: JIS, AISI, ASTM, GB, DIN, EN ,etc.
 Packaging: Standard exporting packing
 Trade Terms: FOB,CFR,CIF,CNF
 Delivery Time: Within 15 working days

等级: 201,202,304,304L,316,316L,430,310S,Etc
 直径: 3-800mm或定制
 长度: 6米或者根据客户需求
 形状: 圆形
 表面: 抛光, 酸洗
 标准: JIS, AISI, ASTM, GB, DIN, EN ,等.
 包装: 标准出口包装
 贸易方式: FOB,CFR,CIF,CNF
 交期: 15个工作日

常规尺寸都有库存, 如果需要定制尺寸, 交货期根据具体数量来确定
 The regular sizes are in stock. If you need custom size, the delivery time will be determined based on the specific quantity.

STAINLESS STEEL STORAGE CENTER

不锈钢仓储中心



ALUMINUM

铝

<https://www.steelttd.com> 

Aluminium coil 铝卷

Grade:1050,1060,1100,3003,3004,3105,5052,
5005,5083,6061,6063,7075,etc
Standard: ASTM SAE EN JIS ISO GB
Size: According to the customer's requests
Thickness: 0.1mm-10.0mm
Width: 100mm-2500mm
Certifications: ISO 9001,SGS,BV

牌号:1050、1060、1100、3003、3004、3105、
5052、5005、5083、6061、6063、7075等
标准:AISI ASTM JIS SUS DIN EN和GB
尺寸:可根据客户要求定做
厚度:0.1 mm - 10.0 mm
宽度:100 mm - 2500 mm
认证:ISO 9001,SGS,BV



铝
ALUMINUM

Aluminum Sheet 铝板

Grade: 1050,1060,1100,3003,3004,3105,5052,
5005,5083,6061,6063,7075,etc
Standard: ASTM SAE EN JIS ISO GB
Thickness: 0.1mm-10.0mm
Width: 900mm-2000mm
Certifications: ISO 9001,SGS,BV

牌号: 1050、1060、1100、3003、3004,3105
5052,5005,5083,6061,6063,7075,等等
厚度:0.1 mm - 10.0 mm
宽度:900mm - 2000 mm
认证: ISO 9001,SGS,BV



ALUMINUM

铝

Aluminum tube 铝管

Material: 5052,5652, 5154, 5254, 5454, 5083, 2014,2014A,2214,2017,2017A,2117,5086, 5056,5456, 2024, 2014, 6061, 6063,6082, etc.

Specification for round pipe:

OD(15mm-160mm) / WT(1-40mm) / Length

(1-12m) Specification for square pipe:

SIZE(7X7mm- 150X150mm) / WT(1-40mm) /

Length(1-12m)

材质:5052、5652、5154、5254、5454、5083、2014、2014a,2214,2017, 2017a,2117,5086, 5056,5456, 2024, 2014、6061、6063、6082等。

圆管规格:外径(15mm-160mm)

WT (1-40mm)

长度(1-12m)

方管规格:尺寸(7X7mm- 150X150mm)

WT (1-40mm)

长度(1-12m)



Aluminum billets 铝坯

Standard: ASTM B221M, GB/T 3191, JIS H4040,etc.
Material:5052、5652、5154、5254、5454、5083、6063、2014、2014A、2214、2017、2017A、2117、5086 etc.
Diameter: 6-800mm

Length: 2m,3m,5.8m,6m,or as required

标准:ASTM B221M, GB/T 3191, JIS H4040等

材料:5052、5652、5154、5254、5454、5083、6063、2014、2014A、2214、2017、2017A、2117、5086等。

直径:6 - 800 mm

长度:2米、3米、5.8米、6米或根据需要



Aluminum ingot 铝锭

ModelNumber:A7,A00,A1,A1B8,ADC12

Application: Manufacture cars,trains,sub-ways,ships,planes

型号:A7,A00,A1,A1B8,ADC12

用途 制造汽车、火车、地铁、船舶、飞机



Aluminum embossed plate 铝压花板

ALLOY:

1050/1060/1100/1200/3003/3005/3105/5005/5052 /5754/8011

THICKNESS: 0.3-4.0mm 4.0-10.0mm

WIDTH: 500-1550mm

LENGTH: 500-9000mm

Pattern type: big five bars, small five bars, three bars, pointer type, diamond shape, orange peel pattern

SURFACE QUALITY: be free from Oil Stain, Dent, Inclusion, Scratches, Stain, Oxide Discoloration, Breaks,

Corrosion, Roll Marks, Dirt Streaks and other defect which will interfere with use

合金:

1050/1060/1100/1200/3003/3005/3105/5005/5052 /5754/8011

厚度:0.3-4.0mm 4.0-10.0mm

宽度:500 - 1550毫米

长度:500 - 9000毫米

表面质量:无油污, 凹痕, 夹杂物, 划痕, 污渍, 氧化变色, 破损, 腐蚀、漆痕、污迹和其他影响使用的缺陷



ALUMINUM

铝

型号和成份表

MODEL AND COMPOSITION TABLE

Grade	Si	fe	Cu	Mu	Zn	T	Single	Total	Al
1050	0.25	0.4	0.05	0.05	0.07	0.05	0.03		99.5min
1060	0.25	0.35	0.05	0.03	0.05	0.03	0.03		99.6min
1100	Si+Fe 0.95		0.05	0.05	0.1	/	0.05	0.15	99.00min
3003	0.6	0.7	0.10	1.0-1.5	0.10	/	0.05	0.15	the rest
3004	0.30	0.7	0.25	1.0-1.5	0.25	/	0.05	0.15	the rest
3105	0.6	0.7	0.30	0.3-0.8	0.40	0.10	0.05	0.15	the rest
5005	0.30	0.7	0.20	0.20	0.25	/	0.05	0.15	the rest
5050	0.40	0.7	0.20	0.10	0.25	/	0.05	0.15	the rest
5052	0.25	0.40	0.10	0.10	0.10	/	0.05	0.15	the rest
5754	0.40	0.40	0.10	0.50	0.20	0.15	0.05	0.15	the rest
5083	0.40	0.40	0.10	0.4-1.0	0.25	0.15	0.05	0.15	the rest
6061	0.4-0.8	0.7	0.15-0.4	0.15	0.25	0.15	0.05	0.15	the rest
6063	0.2-0.6	0.35	0.10	0.10	0.10	0.10	0.05	0.15	the rest
8011	0.5-0.9	0.6-1.0	0.10	0.20	0.10	0.08	0.05	0.15	the rest

常规尺寸都有库存，如果需要定制尺寸，交货期根据具体数量来确定

The regular sizes are in stock. If you need custom size, the delivery time will be determined based on the specific quantity.

ALUMINUM STORAGE CENTER

铝卷 铝材 仓储中心

<https://www.steeltd.com>



铝卷铝材仓储中心

ALUMINUM STORAGE CENTER

PROCESS
CENTER
加工中心

<https://www.steelttd.com> 



加工中心
PROCESS CENTER

**PACKING /
LOADING**
包装/装柜

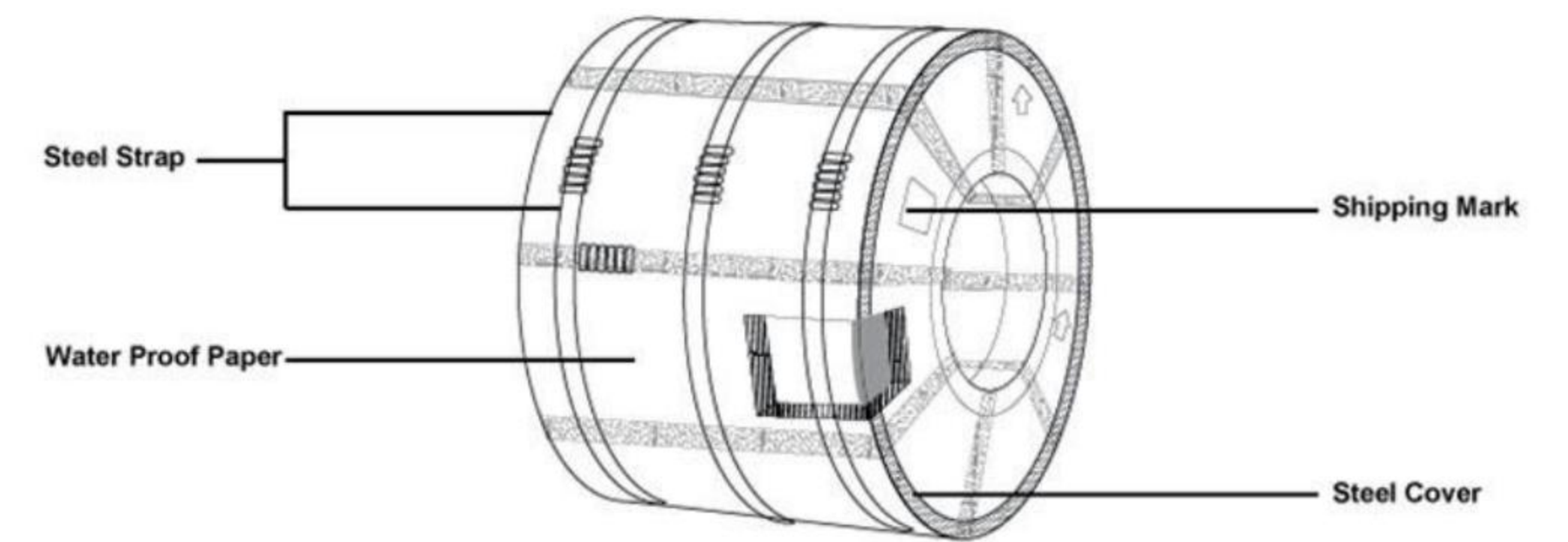
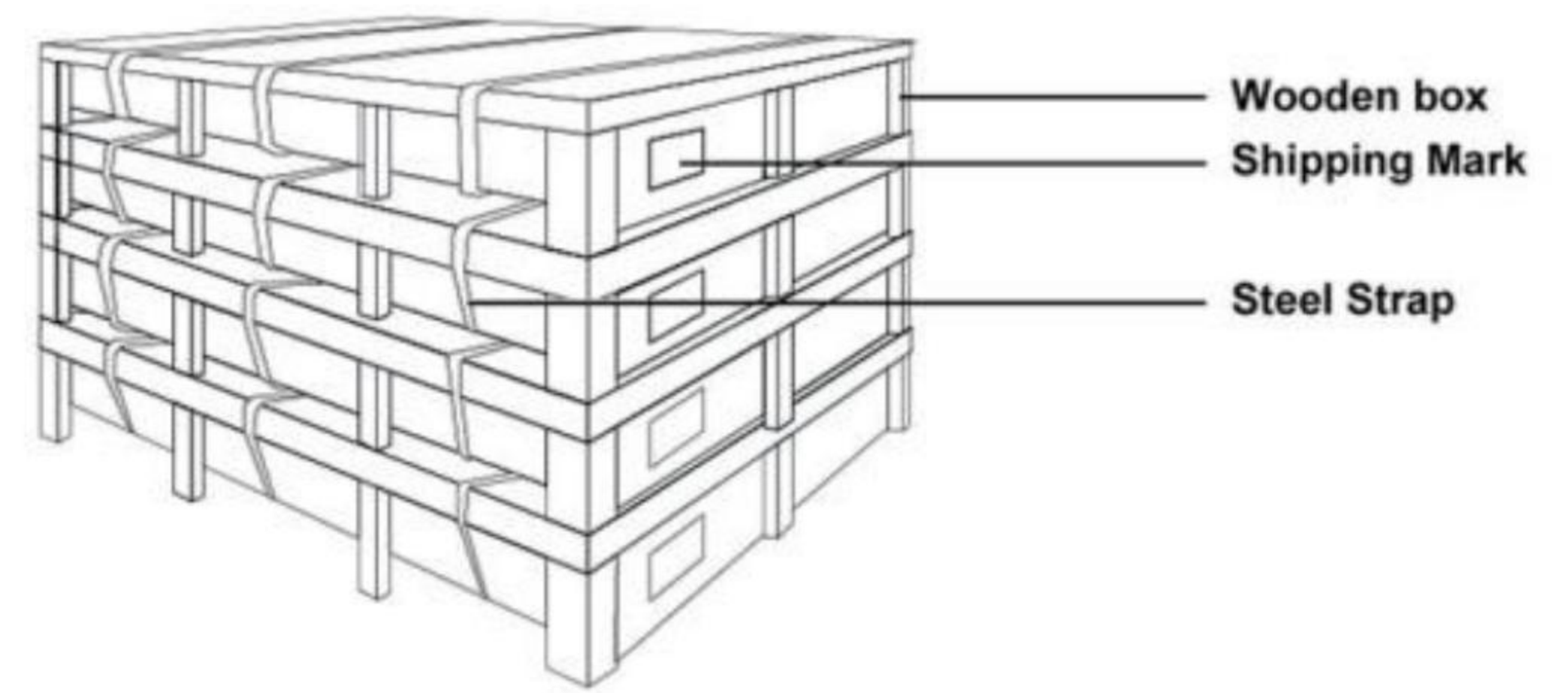
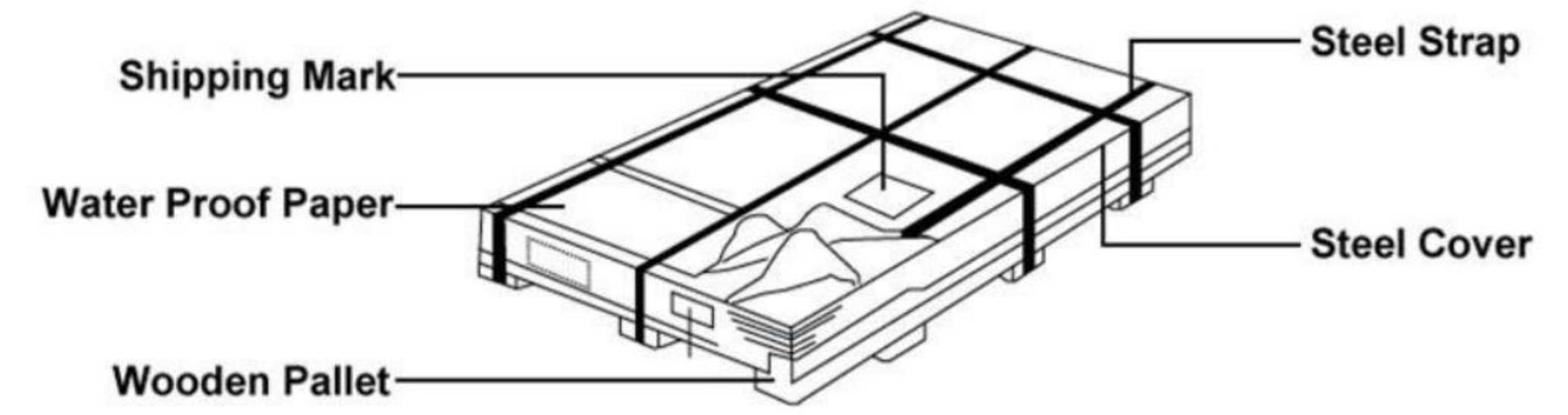

质检篇

QUALITY INSPECTION

03

PART THREE

QUALITY CERTIFICATION

质量认证

<https://www.steeltd.com> 

Raw Material Inspection: Inspect the incoming raw steel material before production to ensure it meets the required standards. Check the dimensions, composition, and surface quality of the steel.

In-Process Inspection: Inspect the steel during the manufacturing process to identify defects, such as cracks, irregularities, or warping. Perform dimensional checks at each stage of production to ensure that the steel is being manufactured to the required specifications.

Final Inspection: Conduct a final inspection of the finished steel products to ensure that they meet the required quality standards. Check the surface finish, dimensions, and overall appearance of the steel.

Testing: Perform a variety of tests on the steel products to verify their quality, such as tensile strength, hardness, impact resistance, and corrosion resistance tests.

Documentation: Record all inspection and test results in a detailed report, including any defects or deviations from the required standards. Use this documentation to identify areas for improvement and to maintain consistency in the quality of your steel products.

Continuous Improvement: Continuously monitor the quality of your steel products and review the inspection and testing process to identify opportunities for improvement. Implement corrective actions as necessary to improve the quality of your steel products and maintain customer satisfaction.

THIRD PARTY INSPECTION

第三方检测

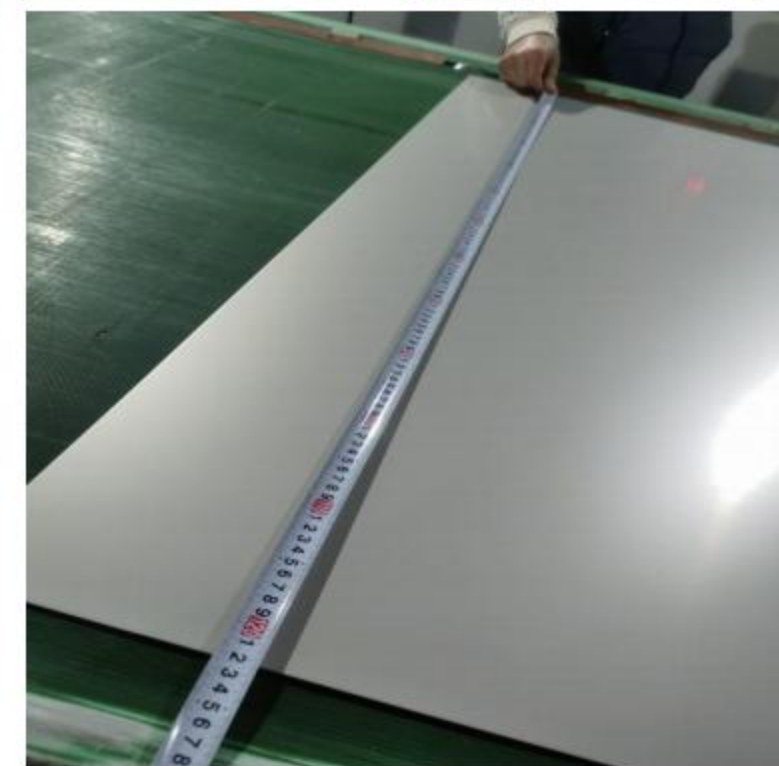
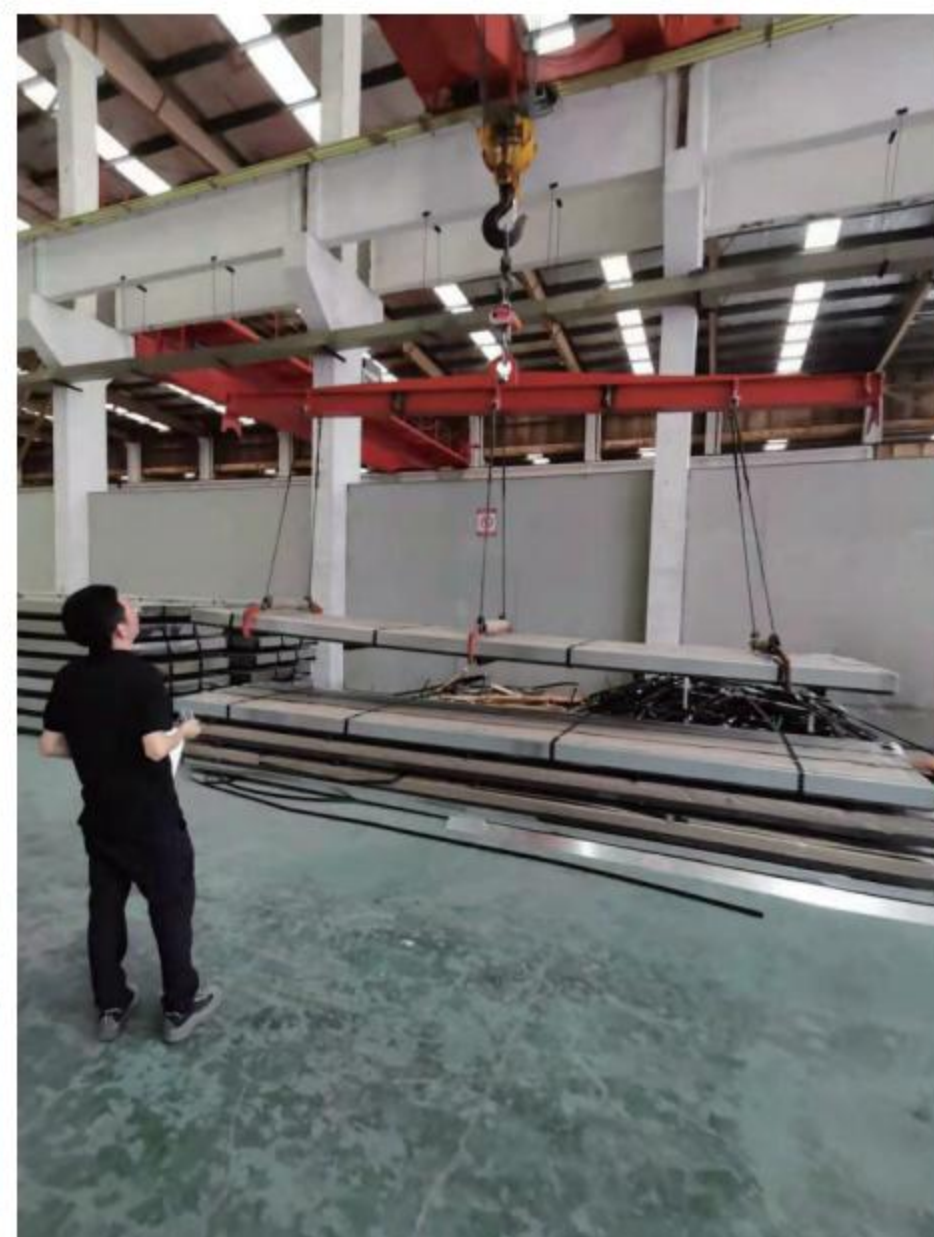
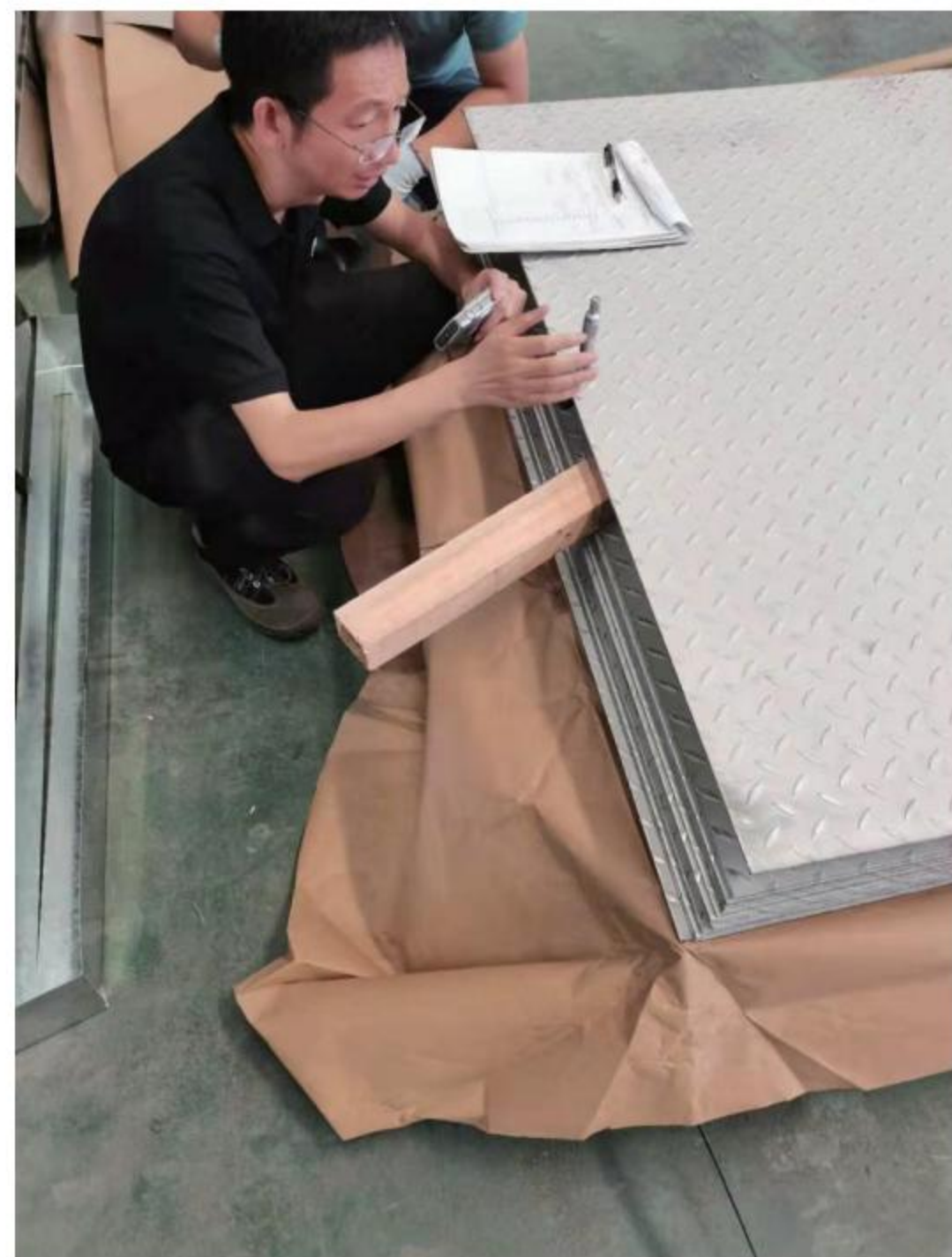

QUALITY CERTIFICATION

质量认证

<https://www.steelttd.com> 



无锡金明简德科技有限公司
产品质量说明书(MILL TEST)

订货单位: Customer:		产品名称: 不锈钢冷轧钢板 Product: Cold rolled stainless steel sheet	
收货单位: Purchaser:		交货状态: 2B 固溶 酸洗 切边 Condition: 2B;Solid solution;Pickling;C	
标准 Specification JIS G 4305:2012	牌号 Grade SUS304L	合同号 Mill's No. 721600-516 客户订单 Customer Order No.	证书编号 Certificate No. 67629222686544121 提单号 Consignment No. 车号 Train Wagon No.

序号 No.	材料号 Material No.	炉号 Heat No	规格 Dimensions (mm)	数量 Quantity	重量 Weight(t)
1	K203112224A11	B2210663	0.8*1000	1	6.862
尺寸及外观 Acceptable Visual And Dimensions:合格 OK				合计 Total 1	6.862

序号 No.	分析 Max. Min.	C%	Si%	Mn%	P%	S%	Cr%	Ni%	N%
1	H	0.021	0.45	1.42	0.030	0.002	18.19	8.06	0.04

序号 No.	位置方向 P.D.	屈服强度 Y.S. Rp0.2 Mpa 常温	抗拉强度 T.S. Rm Mpa 常温	伸长率 EL. A50% 常温	硬度 Hardness HRB 常温
1	2	275	672	62	82

注释 Notes: C=Cutting edge; H=出熔炼分析 Heat analysis; P=成品分析 Product analysis; Y.S.=Yield Strength; 常温=Normal Temperature (Room Temperature); T.S.=Tensile Strength; EL =Elongation; A50:Lo=5.65SQRT(So); 2=横向 Transverse;

声明 Declare

备注 Remark



声明: 本产品已按上述要求制造和检验, 结果符合要求, 特此证明。
We Hereby Certify That Material Described Herein Has Manufactured And Tested With Satisfactory Results In Accordance With The Requirements Of The Above Material Specification.

质检篇
QUALITY INSPECTION



无锡金明简德科技有限公司
Wuxi Jin Ming Jian De Industry&Trade Co., Ltd.

产品质量证明书
PRODUCT QUALITY CERTIFICATE

订货单位 Customer	无锡金明简德科技有限公司		编 号: Serial No:	2845001522						
产品名称 Product	批 号 Lot No	合 金 状 态 Alloy And Temper	规格 (mm) Dimension							
铝板	R9-20041832YH	5052H32	1.5*1250*2500							
技 术 标 准 Technique Standard	GB/T3880-2012		化 学 成 分 标 准 Composition Standard	GB/T3190-2008						
化学成分% Chemical Composition										
元 素 Element	Si	Fe	Cu	Mn	Mg	Cr	Ni	Zn	Ti	Al
标 准 值 Standard Value	≤0.25	≤0.4	≤0.1	≤0.1	2.2-2.8	0.15-0.35	---	≤0.1	---	余量 Remainder
实 测 值 Actual Value	0.050	0.220	0.003	0.036	2.38	0.18	---	0.004	0.015	
机械性能 Mechanical Property										
取 样 方 法 Sampling Method	抗 拉 强 度 (MPa) Tensile Strength		屈 服 强 度 (MPa) Yield Strength		延 伸 率 (%) Elongation					
—	标 准 值 Standard Value	实 测 值 Actual Value	标 准 值 Standard Value	实 测 值 Actual Value	标 准 值 Standard Value	实 测 值 Actual Value				
纵向	210-260	223	>130	174	>6	12				
杯 突 Cup Bulge	/		/	90°折弯 90°bend	合格					
制 耳 率 Earing (%)	/		/	硬 度 Hardness	/					
表 面 质 量 Surface Control	合格			几 何 尺 寸 Dimension Control	符 合 标 准					
氯 含 量 标 准 值 (ml/100gAl) Hydrogen Content Standard Value	—		氯 含 量 实 测 值 (ml/100gAl) Hydrogen Content Actual Value	—						
备 注 Note										

质量、环境、职业健康安全分别通过 ISO9001、TS16949 管理体系认证。本产品的铝、汞、镉、六价铬的含量均符合欧盟 ROHS 指令 2005/618/EC 的要求，砷 < 1000PPm。
Quality, Environment and Professional Health & Safety Management System have Certified as per ISO9001, TS16949. Content of Plumbum, Mercury, Cadmium and hexavalent Chrome conforms to ROHS 2005/618/EC, arsenic is less than 1000PPm.

日期: 2023年2月25日
Date



无锡金明简德科技有限公司
产品质量说明书 (MILL TEST)

订货单位: Customer:	产品名称: 不锈钢冷轧钢带 Product: Cold rolled stainless steel coil									
收货单位: Purchaser:	表面整理: NO.2B Surface Finish: NO.2B									
Spec & Grade 规格牌号: ASTM-A240/A240M-2017:316L	合同号 Mill'S No. SRK902810 客户订单 Customer Order No. 0000884006	证书编号 Certificate No. '6144934198682860 提单号 Consignment No. 0804117424 车号 Train Wagon No.								
序号 No.	材料号 Material No.	炉号 Heat No	规格 Dimensions (mm)	数量 Quantity	重量 Weight (t)					
1	QWP0865C	S681513	0.8*1219*C	1	10.918					
尺寸及外观 Acceptable Visual And Dimensions:合格 OK					合计 Total 1 10.918					
序号 No.	分析 Max. Min.	C%	Si%	Mn%	P%	S%	Cr%	Ni%	Mo%	N%
1	H	0.018	0.54	1.19	0.035	0.002	16.83	10.09	2.08	0.05
序号 No.	位置 方向 P.D.	屈服强度 Y.S. Rp0.2 Mpa 常温	抗拉强度 T.S. Rm Mpa 常温	伸长率 EL A5% 常温	硬度 Hardness HRB 常温					
1	2	276	618	57	82					
注释 Notes	C=Cutting edge; 出熔炼分析 Heat analysis; P=成品分析 Product analysis; Y.S.=Yield Strength; 常温=Normal Temperature (Room Temperature); T.S.=Tensile Strength; EL=Elongation; A5:Lo=5.65SQRT(So); 2=横向 Transverse;									
声明 Declare										
备注 Remarks										

声明: 本产品已按上述要求制造和检验, 结果符合要求, 特此证明。
We hereby Certify That Material Described Herein has Manufactured And Tested Was Satisfactory Results In Accordance With The Requirements of The Above Material Specification.



日期 Date: 2023/02/25 页码 Page: 1/1



TEST REPORT

No. : NJIN2112006439ML
Date : Dec 23, 2021
Page: 1 of 2

CUSTOMER NAME: Wuxi Jin Ming Jian De Industry&Trade Co., Ltd.
ADDRESS: Nongshi Road,#07,Dongbei Tang District,Xi Shan, Wuxi,Jiangsu,CN,Zip:214000

Sample Name : 304 stainless steel sheet
Product Specification : 1#: 1.2x200x200mm/ 2#: 1.5x200x200mm
Manufacturer : TISCO
Buyer : 
Material and Mark : 304

Above information and sample(s) was/were submitted and confirmed by the client. SGS, however, assumes no responsibility to verify the accuracy, adequacy and completeness of the sample information provided by client.

Test Required : Chemical Composition Analysis
SGS Ref. No. : IN-NJ-5801-21449
Date of Receipt : Dec 20, 2021
Testing Start Date : Dec 20, 2021
Testing End Date : Dec 23, 2021
Test result(s) : For further details, please refer to the following page(s)
(Unless otherwise stated the results shown in this test report refer only to the sample(s) tested)

Signed for

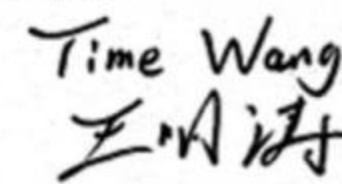
Time Wang

Time Wang
Authorized signatory



Unless otherwise agreed in writing, this document is issued by the Company subject to its General Conditions of Service printed overleaf, available on request or accessible at <http://www.sgs.com/sgs/terms-and-conditions.aspx> and, for electronic format documents, subject to Terms and Conditions for Electronic Documents at <http://www.sgs.com/sgs/terms-and-conditions/terms-document.aspx>. Attention is drawn to the limitation of liability, indemnification and jurisdiction clause printed overleaf. Any holder of this document is advised that information contained herein reflects the Company's findings at the time of its intervention only and within the limits of Client's instructions, if any. The Company's sole responsibility is to its Client and this document does not constitute parties to a transaction from exercising all their rights and obligations under the transaction documents. This document cannot be reproduced except in full, without prior written approval of the Company. Any unauthorized alteration, forgery or falsification of the content or appearance of this document is unlawful and offenders may be prosecuted to the fullest extent of the law. Unless otherwise stated the results shown in this test report refer only to the sample(s) tested and such sample(s) are retained for 30 days only.
Attention: To check the authenticity of testing inspection report & certificate, please contact us at telephone: (86-755) 8307 1443, or email: CN_Sales@sgs.com
1-2F, Building 2, No. 8, Yangling Road, Qidao District, Nanjing, Jiangsu, China 210014 t (86-25) 84920256 f (86-25) 83466107 www.sgs.com.cn
中国·江苏·南京秦淮区永丰大道9号之楼1-2层 邮编: 210014 t (86-25) 84920256 f (86-25) 83466107 e sgs.china@sgs.com
Member of the SGS Group (SGS SA)



TEST REPORT

No. : NJIN2112006439ML
Date : Dec 23, 2021
Page: 2 of 2

Chemical Composition Analysis:
Test Method: ASTM E1086-14 (OES)

Element	C	Si	Mn	P	S	Cr	Ni
Result, %-1#	0.04	0.54	1.11	0.029	0.001	18.21	8.05
Result, %-2#	0.05	0.45	0.94	0.033	0.002	18.17	8.02

Sample Photo(s):



***** End of report *****



Unless otherwise agreed in writing, this document is issued by the Company subject to its General Conditions of Service printed overleaf, available on request or accessible at <http://www.sgs.com/sgs/terms-and-conditions.aspx> and, for electronic format documents, subject to Terms and Conditions for Electronic Documents at <http://www.sgs.com/sgs/terms-and-conditions/terms-document.aspx>. Attention is drawn to the limitation of liability, indemnification and jurisdiction clause printed overleaf. Any holder of this document is advised that information contained herein reflects the Company's findings at the time of its intervention only and within the limits of Client's instructions, if any. The Company's sole responsibility is to its Client and this document does not constitute parties to a transaction from exercising all their rights and obligations under the transaction documents. This document cannot be reproduced except in full, without prior written approval of the Company. Any unauthorized alteration, forgery or falsification of the content or appearance of this document is unlawful and offenders may be prosecuted to the fullest extent of the law. Unless otherwise stated the results shown in this test report refer only to the sample(s) tested and such sample(s) are retained for 30 days only.
Attention: To check the authenticity of testing inspection report & certificate, please contact us at telephone: (86-755) 8307 1443, or email: CN_Sales@sgs.com
1-2F, Building 2, No. 8, Yangling Road, Qidao District, Nanjing, Jiangsu, China 210014 t (86-25) 84920256 f (86-25) 83466107 www.sgs.com.cn
中国·江苏·南京秦淮区永丰大道9号之楼1-2层 邮编: 210014 t (86-25) 84920256 f (86-25) 83466107 e sgs.china@sgs.com
Member of the SGS Group (SGS SA)

ENTERPRISE CULTURE

企业文化

Team development activities

团队拓展活动



we value teamwork, transparency, and innovation. Our culture is built on the foundation of collaboration and mutual respect, where every team member's contribution is appreciated and celebrated. We believe in open communication and transparency in all our dealings, both within the company and with our customers and partners.

我们重视团队合作、透明度和创新。我们的文化建立在协作和相互尊重的基础上，每个团队成员的贡献都受到赞赏和庆祝。我们相信在公司内部以及我们的客户和合作伙伴的所有交易中都应保持开放的沟通和透明度。

企业文化 /Enterprise Culture

诚信.敬业.专业
Integrity. Dedication. Professionalism

企业使命/Enterprise Mission

“我们的使命是提供高质量的金属材料，同时促进可持续发展并与我们的客户和合作伙伴建立持久的关系。”

Our mission is to provide high-quality metal materials while promoting sustainability and building lasting relationships with our customers and partners.

诚信.敬业.专业
Honesty、Dedication、Professionalism

◆ In 2016, Donate books to elementary school students
2016年，捐赠图书给小学生



◆ In 2020, We go to the nursing home to accompany the elderly
2019年，我们去养老院陪伴老人



◆ In 2021, We donate to disaster-stricken areas
2021年，我们为受灾地区捐款



◆ In 2022, we will go to poverty-stricken areas to help people in difficulty
2022年，我们去贫困地区帮助有困难的人

HONORARY PHOTO OF THE COMPANY

公司荣誉照



■ Wuxi-Commerce Chamber of commerce
President enterprise



■ Shandong Chamber of Commerce
Excellent Confucian businessman



■ Wuxi-commerce Chamber of
commerce Excellent team



■ Alibaba East China Region
Influential Online company



■ Shandong Chamber of Commerce
Vice President enterprise



■ Wuxi-commerce Chamber of commerce
Honorary president